

13. NK bare-shaft pumps

NK, centre-line outlet

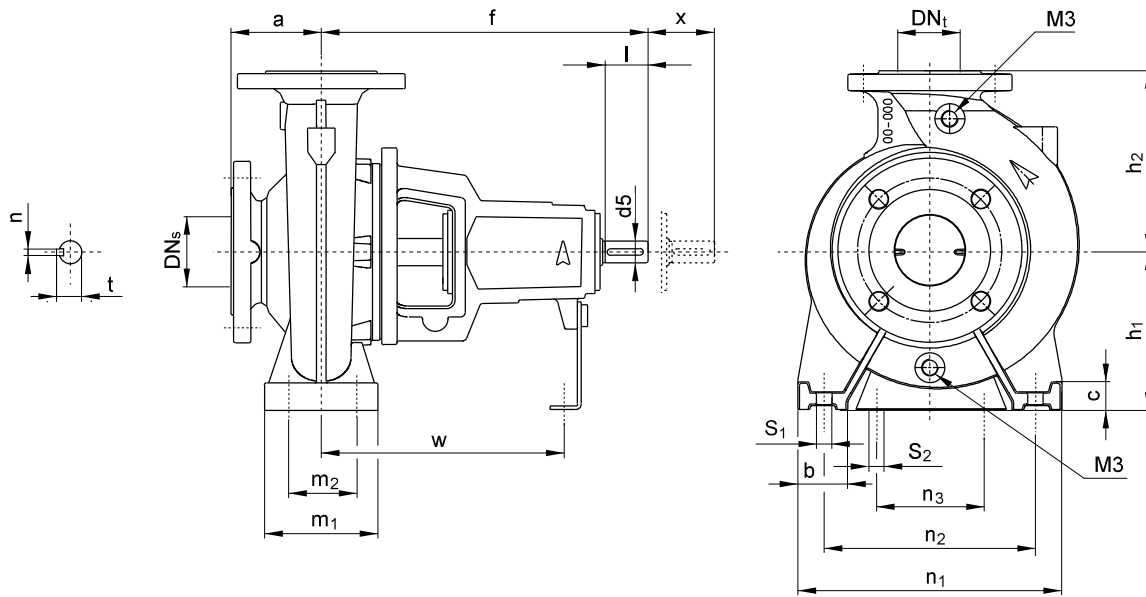

TM019274

M3 Drain plug or priming plug

Type	Pump [mm]						Supporting feet [mm]								Shaft [mm]					Weight [kg]				
	DN _s	DN _t	a	f	h ₁	h ₂	M3	b	m ₁	m ₂	n ₁	n ₂	n ₃	w	S ₁	S ₂	c	d ₅	l	χ ²⁸⁾	t	n	CI ²⁹⁾	SS ³⁰⁾
NK 32-125.1	50	32	80	360	112	140	3/8"	50	100	70	190	140	110	260	M12	M12	14	24	50	100	27	8	34	35
NK 32-125	50	32	80	360	112	140	3/8"	50	100	70	190	140	110	260	M12	M12	14	24	50	100	27	8	34	35
NK 32-160.1	50	32	80	360	132	160	3/8"	50	100	70	240	190	110	260	M12	M12	18	24	50	100	27	8	37	39
NK 32-160	50	32	80	360	132	160	3/8"	50	100	70	240	190	110	260	M12	M12	18	24	50	100	27	8	37	39
NK 32-200.1	50	32	80	360	160	180	3/8"	50	100	70	240	190	110	260	M12	M12	18	24	50	100	27	8	47	49
NK 32-200	50	32	80	360	160	180	3/8"	50	100	70	240	190	110	260	M12	M12	18	24	50	100	27	8	47	49
NK 32-250	50	32	100	360	180	225	3/8"	65	125	95	320	250	110	260	M12	M12	12	24	50	100	27	8	55	59
NK 40-125	65	40	80	360	112	140	3/8"	50	100	70	210	160	110	260	M12	M12	18	24	50	100	27	8	34	40
NK 40-160	65	40	80	360	132	160	3/8"	50	100	70	240	190	110	260	M12	M12	18	24	50	100	27	8	39	41
NK 40-200	65	40	100	360	160	180	3/8"	50	100	70	265	212	110	260	M12	M12	18	24	50	100	27	8	49	51
NK 40-250	65	40	100	360	180	225	3/8"	65	125	95	320	250	110	260	M12	M12	18	24	50	100	27	8	64	59
NK 40-315	65	40	125	470	200	250	3/8"	65	125	95	345	280	110	340	M12	M12	16	32	80	100	35	10	113	104
NK 50-125	65	50	100	360	132	160	3/8"	50	100	70	240	190	110	260	M12	M12	18	24	50	100	27	8	34	43
NK 50-160	65	50	100	360	160	180	3/8"	50	100	70	265	212	110	260	M12	M12	18	24	50	100	27	8	42	45
NK 50-200	65	50	100	360	160	200	3/8"	50	100	70	265	212	110	260	M12	M12	18	24	50	100	27	8	56	52
NK 50-250	65	50	100	360	180	225	3/8"	65	125	95	320	250	110	260	M12	M12	18	24	50	100	27	8	67	57
NK 50-315	65	50	125	470	225	280	1/2"	65	125	95	345	280	110	340	M12	M12	17	32	80	100	35	10	117	109
NK 65-125	80	65	100	360	160	180	3/8"	65	125	95	280	212	110	260	M12	M12	18	24	50	100	27	8	41	47
NK 65-160	80	65	100	360	160	200	3/8"	65	125	95	280	212	110	260	M12	M12	18	24	50	100	27	8	46	47
NK 65-200	80	65	100	360	180	225	3/8"	65	125	95	320	250	110	260	M12	M12	18	24	50	140	27	8	55	58
NK 65-250	80	65	100	470	200	250	3/8"	80	160	120	360	280	110	340	M16	M12	22	32	80	140	35	10	98	96
NK 65-315	80	65	125	470	225	280	3/8"	80	160	120	400	315	110	340	M16	M12	21	32	80	140	35	10	111	116
NK 80-160	100	80	125	360	180	225	3/8"	65	125	95	320	250	110	260	M12	M12	18	24	50	140	27	8	55	58
NK 80-200	100	80	125	470	180	250	3/8"	65	125	95	345	280	110	340	M12	M12	18	32	80	140	35	10	73	89
NK 80-250	100	80	125	470	200	280	3/8"	80	160	120	400	315	110	340	M16	M12	24	32	80	140	35	10	93	108
NK 80-315	100	80	125	470	250	315	3/8"	80	160	120	400	315	110	340	M16	M12	22	32	80	140	35	10	121	128

Type	Pump [mm]							Supporting feet [mm]										Shaft [mm]					Weight [kg]	
	DNs	DNt	a	f	h1	h2	M3	b	m1	m2	n1	n2	n3	w	S1	S2	c	d5	l	X ²⁸⁾	t	n	CI ²⁹⁾	SS ³⁰⁾
NK 80-315 ³¹⁾	100	80	125	530	250	315	3/8"	80	160	120	400	315	110	370	M16	M12	22	42	110	140	45	12	152	156
NK 80-400	100	80	125	530	280	355	1/2"	80	160	120	435	355	110	370	M16	M12	22	42	110	140	45	12	203	197
NK 100-160	125	100	125	360	200	280	1/2"	80	160	120	360	280	110	260	M16	M12	17	24	50	140	27	8	75	84
NK 100-200	125	100	125	470	200	280	1/2"	80	160	120	360	280	110	340	M16	M12	23	32	80	140	35	10	83	86
NK 100-250	125	100	140	470	225	280	1/2"	80	160	120	400	315	110	340	M16	M12	24	32	80	140	35	10	105	111
NK 100-315	125	100	140	470	250	315	1/2"	80	160	120	400	315	110	340	M16	M12	22	32	80	140	35	10	130	132
NK 100-315 ³¹⁾	125	100	140	530	250	315	1/2"	80	160	120	400	315	110	370	M16	M12	22	42	110	140	45	12	161	165
NK 100-400	125	100	140	530	280	355	1/2"	100	200	150	500	400	110	370	M20	M12	22	42	110	140	45	12	233	238
NK 125-200	150	125	140	470	250	315	1/2"	80	160	120	400	315	110	340	M16	M12	19	32	80	140	35	10	129	134
NK 125-250	150	125	140	470	250	355	1/2"	80	160	120	400	315	110	340	M16	M12	22	32	80	140	35	10	133	130
NK 125-250 ³¹⁾	150	125	140	530	250	355	1/2"	80	160	120	400	315	110	370	M16	M12	22	42	110	140	45	12	158	155
NK 125-315	150	125	140	530	280	355	1/2"	100	200	150	500	400	110	370	M20	M12	17	42	110	140	45	12	186	190
NK 125-400	150	125	140	530	315	400	1/2"	100	200	150	500	400	110	370	M20	M12	22	42	110	140	45	12	250	243
NK 125-500	150	125	180	670	400	500	1/2"	125	200	150	625	500	140	500	M20	M16	28	60	110	180	64	18	502	493
NK 150-200	200	150	160	470	280	400	1/2"	100	200	150	550	450	110	340	M20	M12	26	32	80	140	35	10	210	205
NK 150-250	200	150	160	530	280	375	1/2"	100	200	150	500	400	110	370	M20	M12	20	42	110	140	45	12	196	206
NK 150.315.2	200	150	160	530	280	400	1/2"	100	200	150	550	450	110	370	M20	M12	20	42	110	140	45	12	252	255
NK 150-315	200	150	160	530	280	400	1/2"	100	200	150	550	450	110	370	M20	M12	20	42	110	140	45	12	250	253
NK 150-400	200	150	160	530	315	450	1/2"	100	200	150	550	450	110	370	M20	M12	19	42	110	140	45	12	286	291
NK 150-400 ³¹⁾	200	150	160	670	315	450	1/2"	100	200	150	550	450	140	500	M20	M16	19	48	110	180	51.5	14	366	370
NK 150-500	200	150	180	670	400	500	1/2"	125	200	150	625	500	140	500	M20	M16	29	60	110	180	64	18	522	534

28) X is the minimum pull-back length of the bearing bracket required for service of impeller and shaft seal.

29) CI: Cast iron version

30) SS: Stainless steel version

31) Oversize shaft

Oversize pumps

EN 733 describes only the standard types.

The NK range includes bigger models, oversize pumps, for higher flow rates and heads.

As oversize pumps are not according to the standard, dimensions of Grundfos NK oversize pumps may differ from the dimensions of similar pumps from other suppliers.

NB, NK 150-500

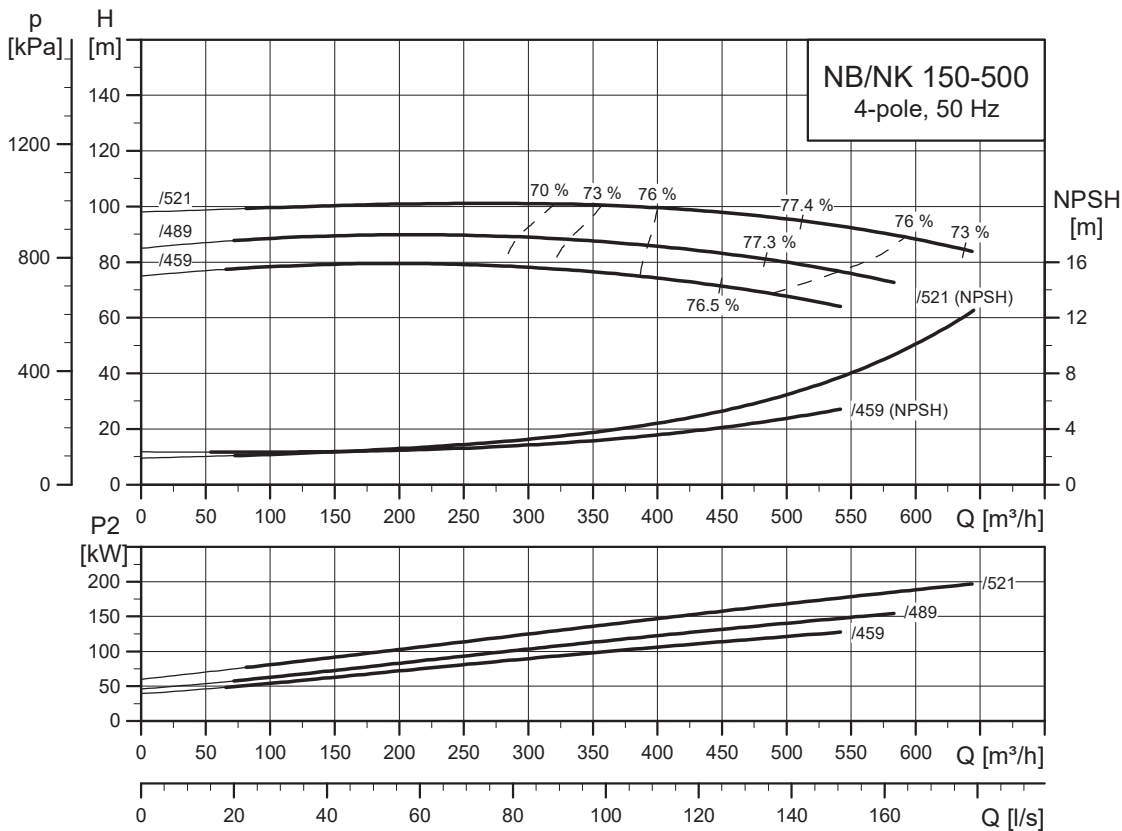

TM035156

NB, NK 200-400

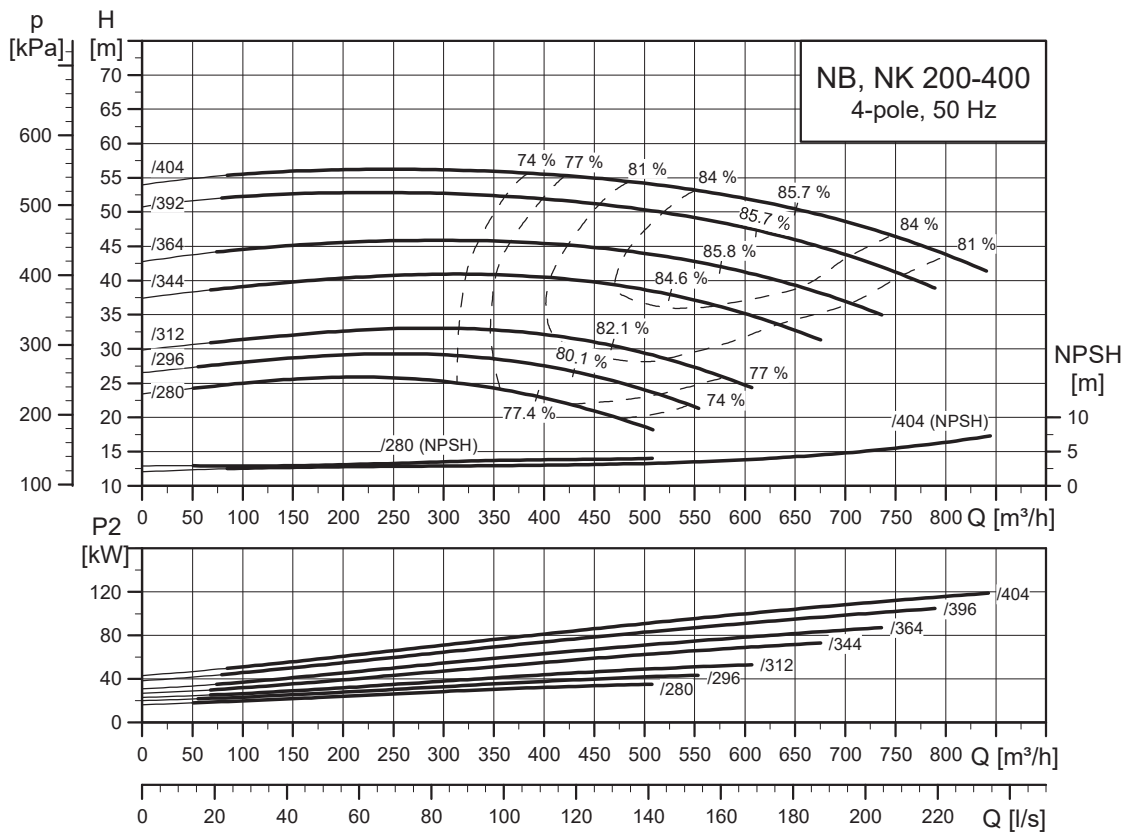

TM044935

NB, NK 150-400

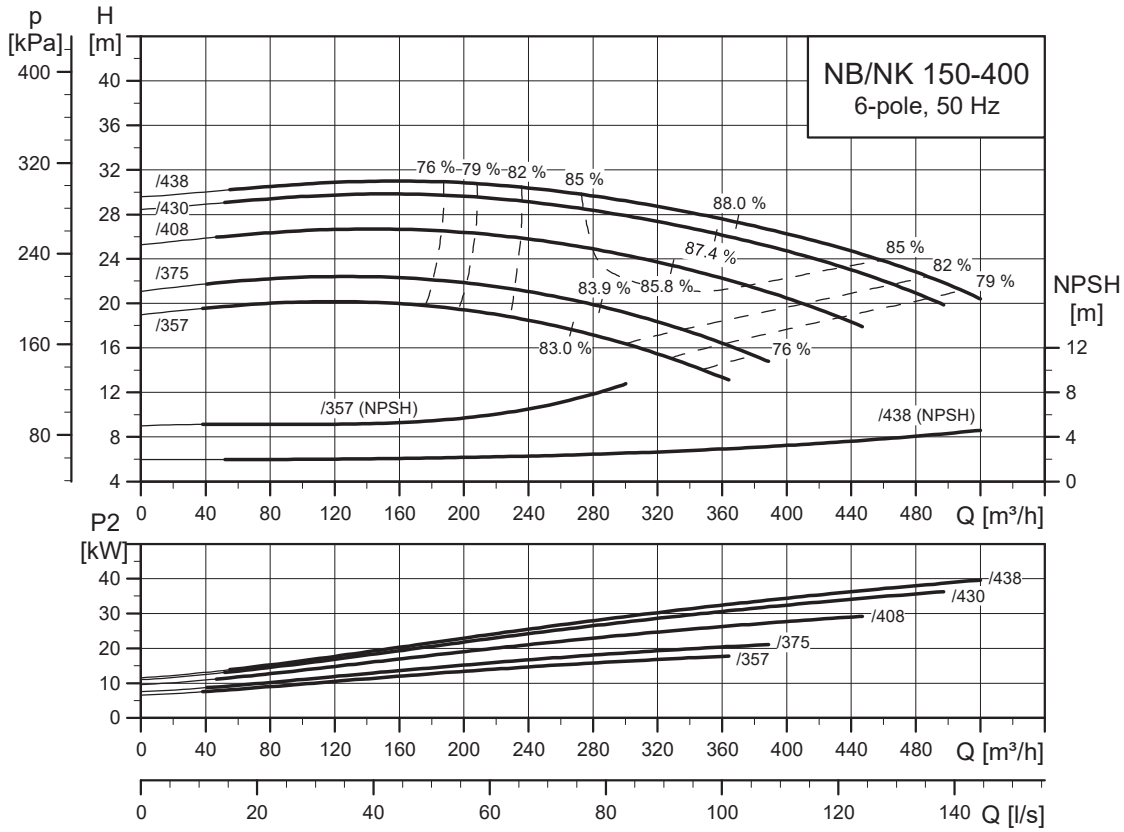

TM035172

NB, NK 150-500

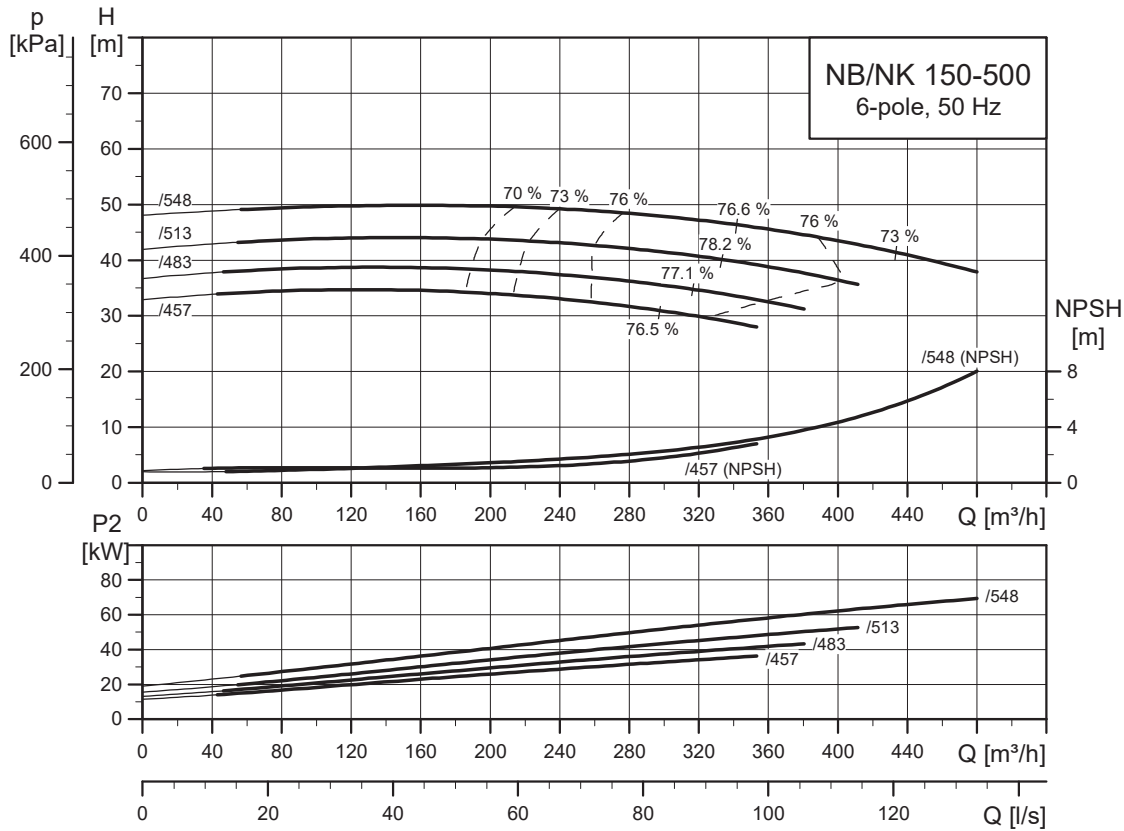

TM035173